

**Note: Air-Way is proud to be an active participant in the development of the text and the video format versions of SAE J1273 -**

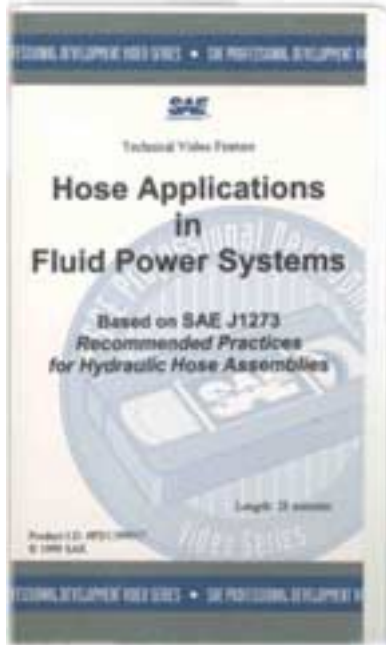

**Recommended Practices for Hydraulic Hose Assemblies. These SAE documents are intended as guides to consider when selecting, routing, fabricating, installing, replacing, maintaining, and storing hose for fluid power systems. Proper consideration of these factors can have a direct impact on the satisfactory performance of hose/tube assemblies and the fittings to which they**

**are attached. Following the recommended practices outlined in SAE J1273 can reduce the likelihood of component or system failure. Air-Way supports these recommendations and can make a copy of the videotape version available to you on request. Please contact customer service for details.**

**Hose and Tube Routing**

The following figures provide a summary of commonly accepted best practices for hose and tube routing. These figures are not intended to be all-inclusive, but represent situations frequently encountered in routing hydraulic system conductors. In addition to these figures, several general guidelines should be observed in the planning of a fluid power system layout.

1. Hydraulic system hose/tube assemblies and connectors are designed for the internal forces of conducted fluids. They are not designed to carry significant external loads. The routing and appropriate use of guards for these assemblies should protect them from external forces that could damage the hose/tube assembly or the fittings to which they are connected. Special attention should be given in areas where the assemblies are likely to be used as a step or are in exposed areas subject to impact, abrasion or snagging.

2. The pressurized fluids contained by the connectors and conductors in a fluid power system can cause property damage or personal injury. Some of the potential conditions to consider include:

a. Fluid Injection - Pinhole leaks in high-pressure circuits can allow the release of pressurized fluid that can

penetrate through the skin. **Fluid injection injuries may cause severe injury and potential loss of limb.** System planning should minimize the potential for fluid injections through careful routing, and the appropriate use of guards, shields and warnings in areas normally occupied by operators or maintenance personnel. **In the event of a fluid injection type injury, immediately seek medical treatment. Do not delay or treat as a simple cut.**

b. Burns - Hydraulic system fluids can reach temperatures high enough to burn skin. Component placement and system routing be planned to minimize operator exposure to hot surfaces as well as potential contact with escaping fluids. Appropriate use of guards, shields and warnings should be considered in areas normally occupied by operators or maintenance personnel.

c. Physical Damage - In the event of a failure of a system component, physical damage can result from contact with ejected components, whipping hose or falling mechanisms. Loss of system control functions may result, such as sudden retraction of self-return mechanisms or loss of steering or brakes.

3. Proper alignment and assembly of components in a fluid power system is a major factor in the elimination of leaks and other system problems. Adequate space should be provided for access in all areas where connections need to be made during assembly or maintenance.

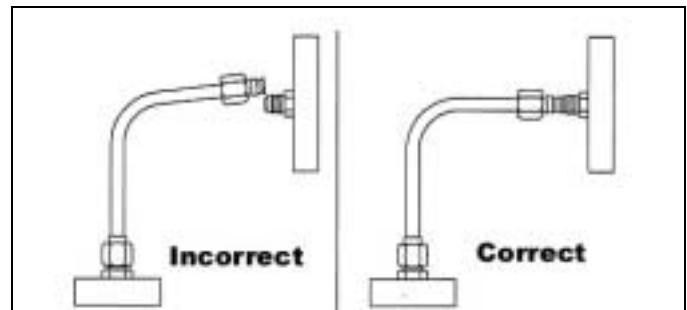

**Fig.R1 Check for proper component alignment.** Correct misalignment prior to final assembly. Align hose/tube assembly allowing hand connection. To assure proper alignment, two to three turns of nut should be easily permitted by hand.

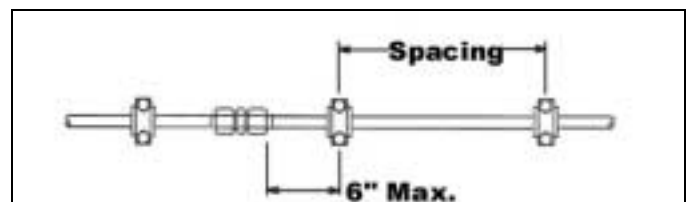

**Fig.R2 Use proper clamping to reduce strain due to vibration.** See Table R1 for recommended clamp spacing. Final tightening of hose/tube connections should be completed before tightening of supports and clamps.



Table R1. Clamp Spacing	
Tube O.D.	Spacing
1/4" - 1/2" (6.4 - 12.7 mm)	3 ft. (0.9 m)
5/8" - 7/8" (15.9 - 22.2 mm)	4 ft. (1.2 m)
1" (25.4 mm)	5 ft. (1.5 m)
1 1/4" and up (31.8 mm and up)	6 ft. (1.8 m)

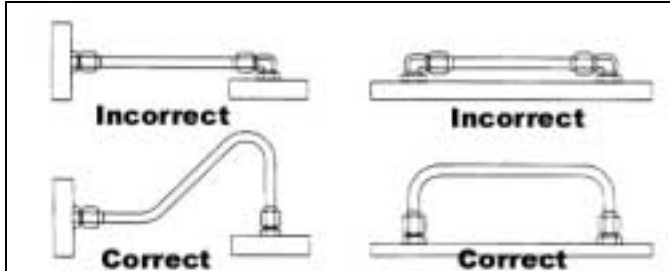

Fig.R3 Use bends in hose/tube assemblies to reduce strain on components and to compensate for tolerance stack-up in assemblies.

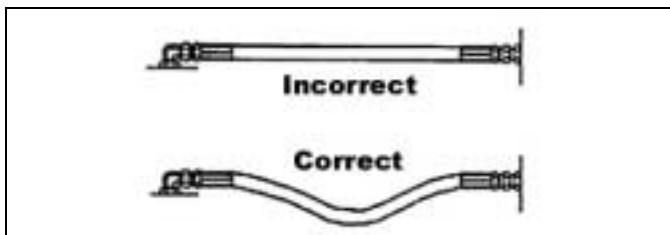

Fig.R4 Allow extra hose length to reduce strain on components, to compensate for tolerance stack-up in assemblies and to allow for hose length changes when pressurized.

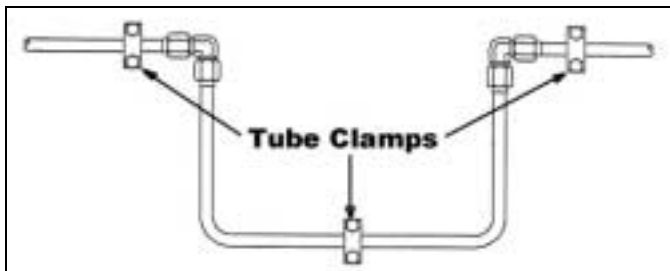

Fig.R5 Use U-Bends to allow for expansion and contraction of rigid lines.

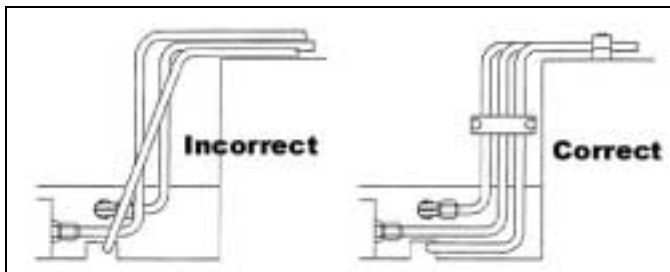

Fig.R6 Route hose/tube assemblies to allow ease in assembly, maintenance and proper clamping.

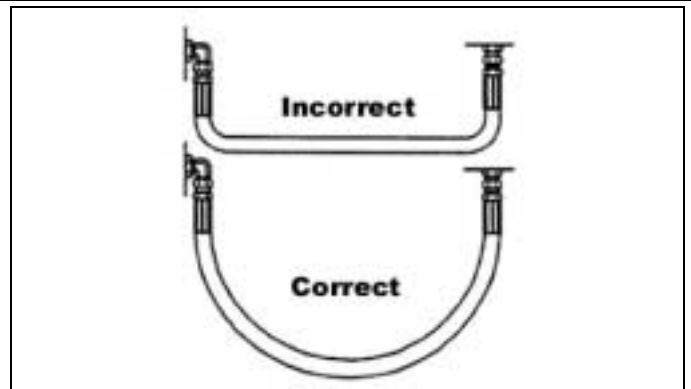

Fig.R7 Hose manufacturers minimum bend radius recommendations should be observed for both static connections and for connections to moveable mechanisms. Bend radius for connections with moveable mechanisms should be checked over the entire range of motion to prevent damage to the hose/tube assembly or connectors.

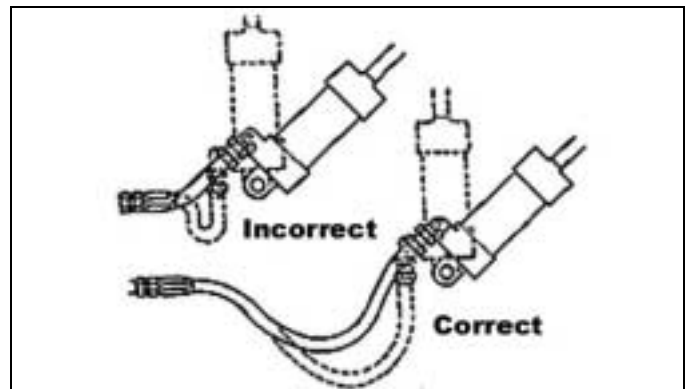

Fig.R8 Provide adequate hose length to allow for movement of mechanisms. System design should provide sufficient hose length to prevent strain on connections at extreme extension and to prevent kinking of hose at any point throughout the entire range of motion. Either tensile strain or kinking can cause premature failure of hose/tube assemblies and connectors.

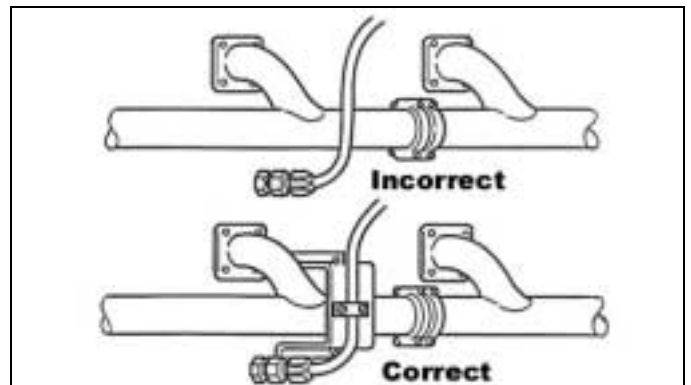
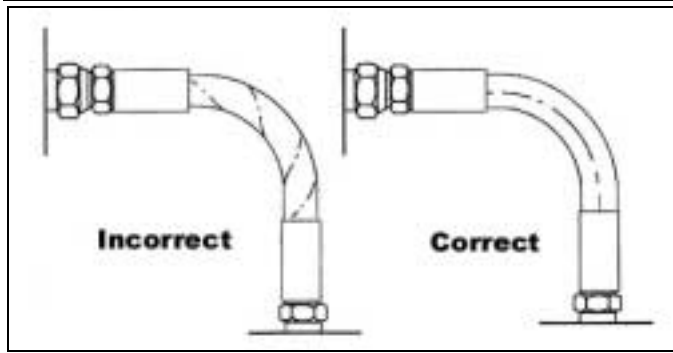
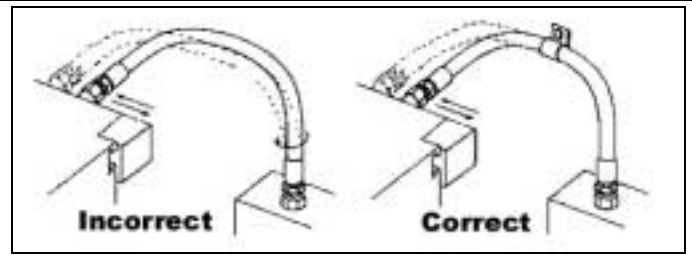

Fig.R9 Provide shields/guards to protect hose/tube assemblies from potential damage. Examples include; heat sources such as exhaust manifolds/mufflers, abrasion/rubbing contact, contact with external objects.

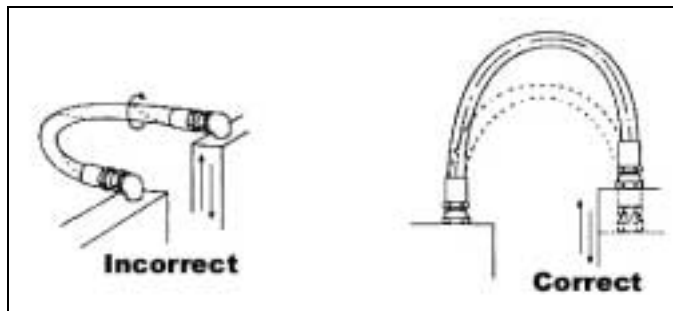



**Fig.R10 Use two wrenches when making hose connections to prevent hose twist. The hose lay-line may be used for visual reference.** Twisting of the hose will result in reduced pressure capability and can cause loosening of the fitting when the hose is pressurized.



**Fig.R12 When routing hose assemblies between components which move in more than one plane relative to each other, provide clamping as required to isolate the motion to a single plane of bend for the hose. In installations where it is impossible to adequately clamp the hose assembly, use of live swivel joints in conjunction with proper clamping is recommended. Evaluate the total range of motion of the hose assembly to ensure that the minimum bend radius is not violated.** Twisting of the hose will result in reduced pressure capability and can cause loosening of the fitting when the hose is pressurized. Live swivels permit rotational movement of the components under pressure without twisting of the hose. Bending the hose tighter than the minimum bend radius can exert excessive force on the connections and will reduce the hose service life.



**Fig.R11 When routing hose assemblies between components that move in a single plane relative to each other, provide connections that result in movement of the hose in the same plane of motion without twisting. Evaluate the total range of motion of the hose assembly to ensure that the minimum bend radius is not violated.** Twisting of the hose will result in reduced pressure capability and can cause loosening of the fitting when the hose is pressurized. Bending the hose tighter than the minimum bend radius can exert excessive force on the connections and will reduce the hose service life.

